

Super Slim Ceiling Mounted Air Handling Unit LFPS Series LFPS10

Model Number Configuration

LFPS10-4+1: 4 + 1 Row Super Slim Ceiling Mounted

LFPS10-6+1: 6 + 1 Row Super Slim Ceiling Mounted

PERFORMANCE DATA

RETURN AIR

Model	Air Flow	4 Rows Cooling				1 Row Heating			External Excess Pressure			Motor Power			Weight
		Total	Sensible	Water Flow	Water Resistance	Rated Heating	Water Flow	Water Resistance	I	II	III	I	II	III	
	l/s	kW	kW	l/s	kPa	kW	l/s	kPa	Pa	Pa	Pa	kW	kW	kW	kg
LFPS10-4+1	278	5.6	4.2	0.3	5.2	3.2	0.1	0.7	—	—	190	—	—	0.18	84.2
LFPS10-6+1	278	7.8	5.2	0.4	14.4	3.2	0.1	0.7	—	—	150	—	—	0.18	91

Notes for Return Air:

1. Cooling: The water in/out temp. is 7°C/12°C; the air in temp. is 27°C DB / 19.5°C WB
2. Heating: The water in temp. is 80°C / 50°C; the air in temp. is 21°C DB..
3. The motor power offered is the motor output power.
4. The above performance is for reference only. Different air and water conditions would lead to different cooling capacity.

SPECIFICATION

- **Coil:**
LFPS010W-LFPS 120W : ϕ 9.52mm, copper tube, aluminium fins
LFPS135W-LFPS 300W: ϕ 12.7mm, copper tube, aluminium fins
- **Fan and motor:**
LFPS 010W-LFPS025W: direct driven, forward curved centrifugal fan|
LFPS 030W-LFPS 300W: belt driven, forward curved centrifugal fan
- **Filter: 15mm panel filter**
- **Cabinet: 25mm thick double skinned panel**
- **Drip-tray: powder painting steel sheet**

Diagrams of: LFPS 010

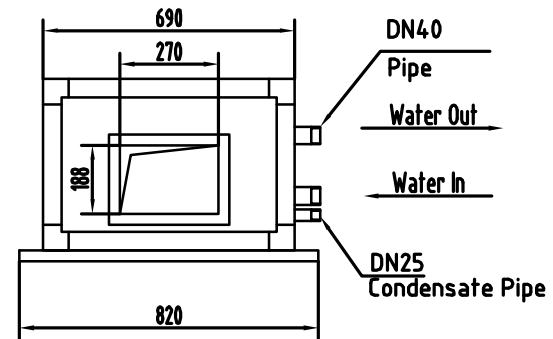
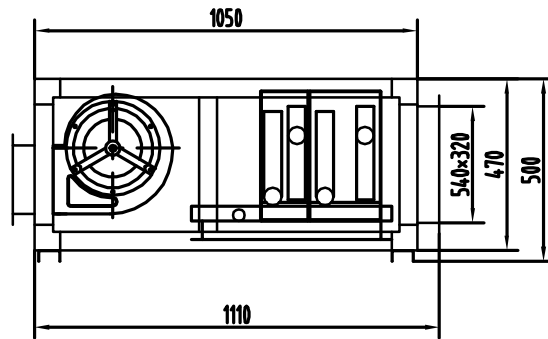

Air Flow l/s.	278	
External Overbottom Pressure Pa	190	150
Coil Rows: Cooling+Heating	4+1	6+1
Fan Model(Drive Type)	KDF2WS(Direct Drive)	
Motor Power-Pole	0.18KW-4	
A FLA	0.65A	
Voltage	415V/30ph/50HZ	
Coil Diameter mm/Fins:Width×Height mm	3/8"(ø9.52)/420×305(tube no:12)	
Filter:Length×Width×Thickness mm/quantity	532×312×15/1	

Note: The unit shown is of left hand type.

DRAWN BY: GUO JINGPENG	DATE: 24/02/2012		
APPROVED Q.A.: WU MEIJUN	APPROVED ENG.: ZHANG JINGFEI	TITLE: Water Cooled Fan Coil Unit LFPS TYPE	
MODEL: LFPS 010	DRANG NO.: 01	ISSUE: 01	SHEET SIZE: A4

Wiring Diagram

415V/3Ph/50Hz

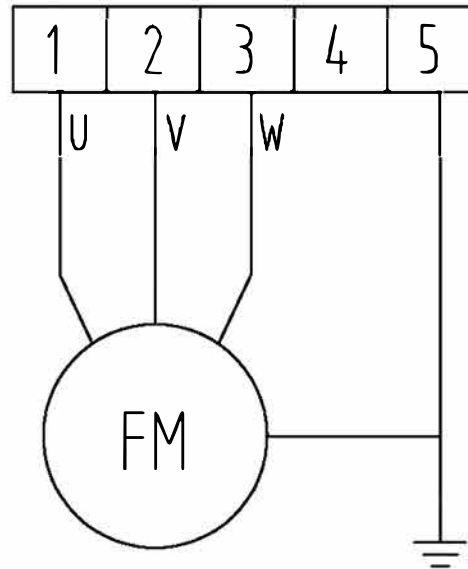

LFPS10

FAN CURVE

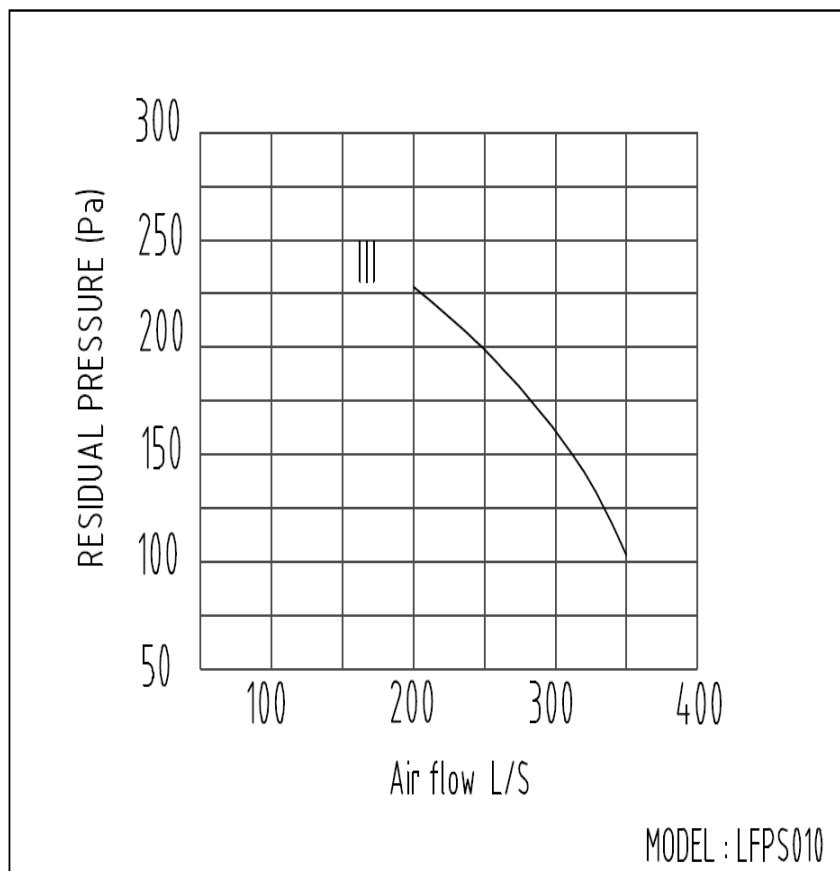

DRAWN BY: GUO JINPENG	DATE: 13/11/2019		
APPROVED O.A.: WU MEIJUN	APPROVED ENG.: ZHANG JINGFEI	TITLE:Water Cooled Fan Coil Unit LFPS TYPE	
MODEL: LFPS010	DRAWING NO.: 01	ISSUE: 01	SHEET SIZE: A4

LFPS10

NOISE CURVE

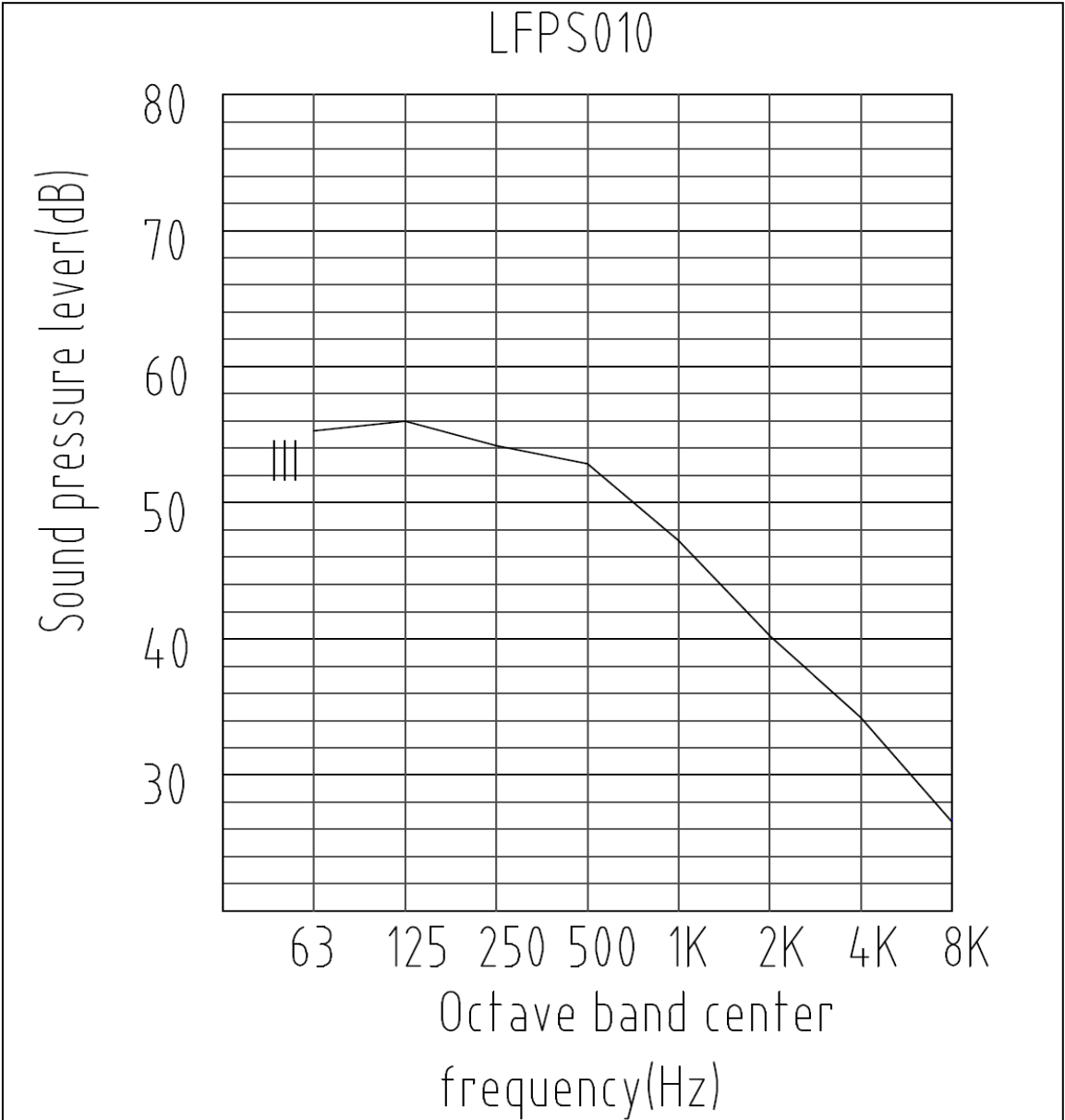

DRAWN BY: GUO JINGPENG	DATE: 14/11/2009			
APPROVED Q.A.: WU MEIJUN	APPROVED ENG.: ZHANG JINGFEI	TITLE: Water Cooled Fan Coil Unit LFPS TYPE		
MODEL: LFPS010		DRAWING NO.: 01	ISSUE: 01	SHEET SIZE: A4